

Beitels en toebehoren voor hakhamer met 0.401" ronde insteek

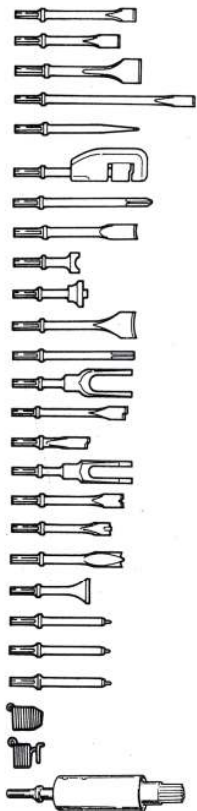

Model	Omschrijving	Bestelnummer
MC-66	Straight Cutting Chisel	40/21/9193
MC-67	Angle Cutting Chisel	40/21/9201
MC-68	Wide Cutting Chisel	40/21/9219
MC-69	Long Cutting Chisel	40/21/9227
MC-70	Punch	40/21/9235
MC-71A	Crimping Tool	40/21/9243
MC121-72	Silencer Cutter	40/21/9250
MC-73	Tail Pipe Cutter	40/21/9276
MC121-74	Tie Rod Tool	40/21/9284
MC121-75	Bushing Driver	40/21/9292
MC121-76	Concave Face Chisel	40/21/9300
MC121-77	Bushing Remover	40/21/9318
MC121-79	1" Fork Chisel	40/21/9326
MC121-81	7" Shock Absorber Chisel	40/21/9342
MC121-80	4 1/2" Shock Absorber Chisel	40/21/9334
MC121-84	3/4" Fork Chisel	40/21/9354
MC121-87	Spotweld Breaker	40/21/9367
MC121-88	Edging Tool	40/21/9375
MC121-89	Double Edged Ripper	40/21/9383
MC121-90	Body Forming Dolly	40/21/9390
MC121-91-6	Piercing Punch	40/21/9409
MC121-91-8	Piercing Punch	40/21/9417
MC121-91-10	Piercing Punch	40/21/9425
AVC1-83	Safety Retainer	40/01/0659
AVC10-183A	Quick Change Retainer	40/01/0980
MC121-NSA	Needle Scaler Attachment	

Beitels en toebehoren voor hakhamer met 10 mm zeskante insteek

Model	Omschrijving	Bestelnummer
MC-66H	Straight Cutting Chisel	40/08/3062
MC-67H	Angle Cutting Chisel	40/08/3070
MC-68H	Wide Cutting Chisel	40/08/3088
MC-69H	Long Cutting Chisel	40/06/2363
MC-70H	Punch	40/08/3096
MC121-72H	Silencer Cutter	40/06/2371
MC-73H	Tail Pipe Cutter	40/04/9725
MC121-76H	Concave Face Chisel	40/06/2405
MC121-80H	4 1/2" Shock Absorber Chisel	40/06/2439
MC121-84H	3/4" Fork Chisel	40/05/7694
MC121-87H	Spotweld Breaker	40/05/7702
MC121-88H	Edging Tool	40/05/7710
MC121-89H	Double Edged Ripper	40/05/7728
MC121-90H	Body Forming Dolly	40/05/7736
AVC1-83	Safety Retainer	40/01/0659
AVC10-183A	Quick Change Retainer	40/01/0980

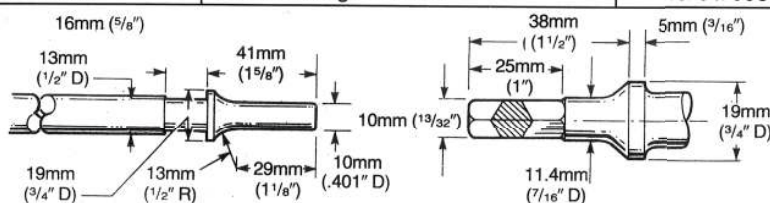

Bouterol voor rivethamers

Type MC 121, AVC 10-12-12

DIA. 10,2 (0.401")

Type AVC 26

DIA. 12,6 (0.498")

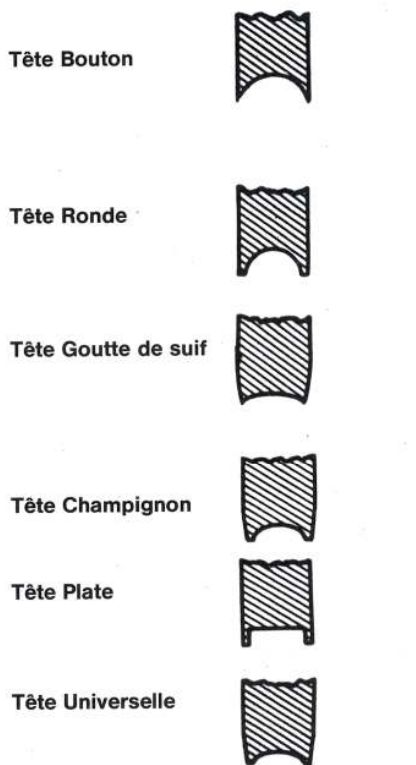

Referentie	Ø Rivet mm	Bestelnummer	Referentie	Ø Rivet mm	Bestelnummer
AV1-22A-4	3	40/13/6580	AV24-222A-8 AV24-222A-10 AV24-222A-12	6 8 9	40/21/8781 40/21/8799 40/21/8801
AV1-22A-6	5	40/13/6598			
AV1-22A-8	6	40/21/8146			
AV1-22A-10	8	40/21/8153			
AV1-22B-4	3	40/13/6549	AV24-222B-8 AV24-222B-10	6 8	40/13/6838 40/13/6846
AV1-22B-6	5	40/13/6556			
AV1-22B-8	6	40/21/8211			
AV1-22B-10	8	40/13/6572			
AV1-22C-4	3	40/13/6622	AV24-222C-6 AV24-222C-8	5 6	40/13/6853 40/13/6861
AV1-22C-5	4	40/13/6630			
AV1-22C-6	5	40/13/6648			
AV1-22C-8	6	40/13/6655			
AV1-22C-10	8	40/13/6663			
AV1-22F-8	6	op aanvraag	AV24-222F-10	8	40/13/6911
AV1-22G-6	5	40/21/8419	AV24-222G-8 AV24-222G-10	6 8	40/21/9086 40/21/9094
AV1-22G-8	6	40/21/8427			
AV1-22G-10	8	40/21/8435			
AV1-22H-3	2	40/21/8468	AV24-222H-6 AV24-222H-10	5 8	40/21/9151 40/21/9177
AV1-22H-5	4	40/21/8484			
AV1-22H-6	5	40/21/8492			
AV1-22H-8	6	40/21/8500			

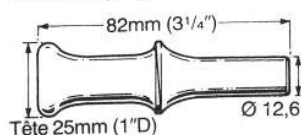
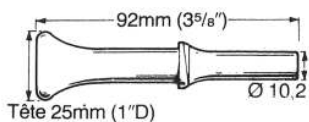
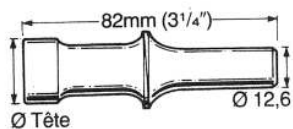
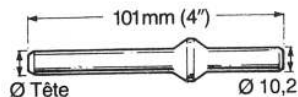

HALF AFGEWERKTE BOUTEROLLEN

Referentie	Ø Rivet mm	Bestelnummer	Referentie	Ø Rivet mm	Bestelnummer
AV1-22S-16	13	40/21/8062	AV1-126D	25	40/21/8534
AV1-22S-20	16	40/21/8070			
AV1-22S-24	19	40/21/8088			
AV1-22S-22	22	40/21/8096			

BOUTEROLLEN MET VERGROOT VOETVLAK

Referentie	Ø Rivet mm	Bestelnummer	Referentie	Ø Rivet mm	Bestelnummer
AV24-222S-26	21	40/21/8724	AV24-126D	25	40/13/6929
AV24-222S-38	30	40/21/8732			

Pneumatische breekhamers van 2.6 tot 5.0 kg



IR2PS

Beitels voor IR2PS			
Lengte mm	Breedte mm	Model	CA-nummer
155	punt	puntbeitel	40/45/8875
165	25	platte beitel	40/45/8883
155	50	platte beitel	40/45/8891

Beitels voor IR3PS, IR5PS en MK500		
Lengte mm	Model	CA-nummer
250	puntbeitel	59/31/0060
300	puntbeitel	40/76/5385
350	puntbeitel	59/31/0061
450	puntbeitel	59/31/0062
750	puntbeitel	59/31/0064
250	steekbeitel	59/31/0066
450	steekbeitel	59/31/0068
600	steekbeitel	59/31/0080
1000	steekbeitel	59/31/0082
1000	steekbeitel	59/99/7948
215	gebogen beitel	59/31/0072
215	platte brede beitel	59/31/0074
210	gebogen beitel	59/31/0078
215	gebogen beitel	59/31/0079
450	gebogen beitel	59/31/0087
250	holle beitel	59/31/0070
250	kambeitel	40/77/1599
40	bouchardeerkop	40/76/7050
40	bouchardeerkop	40/76/7068
250	bouchardeerhouder	40/76/7043



IR3PS



IR5PS



MK500

Model	Beitel insteek	Slagen/ minuut	Slaglengte	Zuiger-diameter	Gewicht kg	Lengte mm	Lucht-Aansl. NPTF	Slang mm	CA-nummer
Perslucht breekhamers									
IR2PS	12.5x55	2850	50	20	2.6	254	3/8"	10	41/04/6020
IR3PS	19x50	3850	37	37	3.5	318	1/2"	13	41/04/6030
IR5PS	19x50	2650	60	28	5.0	408	1/2"	13	41/04/6050
MK500	19x50	2800	46	28	5.0	380	3/8"	13	59/31/0030

Pneumatische Riveteerhamers

Deze pneumatische riveteerhamers zijn trillingsarm en stil in gebruik. De handgreep en cilinder zijn elastisch. De extra dempingselementen en geluidsdempers maken deze machines zeer milieu- en gebruiksvriendelijk.



G75



FK 120.3



Model 1	Diameter rivet	CA nummer
Rivetgeleider indrijf voor R23x65mm		
5236606	6	59/45/0480
5236608	8	59/45/0481
5236610	10	59/45/0482
5236612	12	59/45/0483
5236614	13/14	59/45/0484
5236616	16	59/45/0485
5236618	18	59/45/0486
5236619	19	59/45/0487
5236620	20	59/45/0488
Rivetgeleider indrijf voor R31x70mm		
5238610	10	59/45/0460
5238612	12	59/45/0461
5238614	13/14	59/45/0462
5238616	16	59/45/0463
5238618	18	59/45/0464
5238620	20	59/45/0465
5238622	22	59/45/0466

Model 2	Diameter rivet	Diameter conus	CA nummer
Rivetgeleider uitdrijf voor R23x65mm			
5236510	8-10	6-10	59/45/0489
5236512	10-13	8-12	59/45/0490
5236514	12-14	10-14	59/45/0491
5236516	14-16	12-16	59/45/0492
5236518	16-19	14-18	59/45/0493
5236520	18-20	16-20	59/45/0494
Rivetgeleider uitdrijf voor R31x70mm			
5238510	8-10	6-10	59/45/0468
5238512	10-13	8-12	59/45/0469
5238514	12-14	10-14	59/45/0470
5238516	14-16	12-16	59/45/0471
5238518	16-19	14-18	59/45/0472
5238520	18-20	16-20	59/45/0473
5238522	19-22	18-22	59/45/0474

Model 3	Nuttige lengte mm	Breedte mm	CA nummer
Afsteekbeitel voor R23x65mm			
30536140	140	30	59/45/0495
Afsteekbeitel voor R31x70mm			
30538141	220	30	59/45/0475

Model	Beitel-Insteek mm	Slag-lengte mm	Lucht verbruik l/sec	Zuiger diameter mm	Lengte mm	Gewicht kg	Aansluiting	Slang mm	CA nummer
Pneumatische riveteerhamers									
FK 120.3	R23x65	197	10.0	30	555	8.8	3/8"	13	59/45/0457
FK141.3	R31x70	300	15.8	30	690	14.1	3/8"	15	59/54/0458
Pneumatische tegenhouders									
G 65 K	R31x70	23	-	65	86	3.5	3/8"	13	59/45/0452
G 75	R31x70	90	-	75	245	9.0	3/8"	13	59/45/0454

Pneumatische Hakhamers

Beitels voor model 9001-EU			
Ref.	mm	Model	CA-nummer
9001-279	305	uitdrijf	40/81/8424
9001-282	241	uitdrijf	40/81/8457
9001-285	240	uitdrijf	40/99/9801
9001-286	300	uitdrijf	40/99/8004

Beitels voor model 9001-EU			
Ref.	mm	Model	CA-nummer
9001-276-12	305	plat	40/99/9800
9001-276-18	455	plat	40/99/9803
9001-276-9 1/2	241	plat	40/81/8374

Beitels voor model 9001-EU			
Ref.	mm	Model	CA-nummer
9001-297-12	305	punt	40/13/8180
9001-297-18	455	punt	40/13/8198

Beitels voor model 9001-EU			
Ref.	mm	Model	CA-nummer
9001-277-9 1/2	241	side cut	40/81/8382

Beitels voor model 9001-EU			
Ref.	mm	Model	CA-nummer
9001-295-9 1/2	241	ripper	40/81/8390

Beitels voor model 9001-EU			
Ref.	mm	Model	CA-nummer
AS-209	238	brede	40/21/9490
AS-211	238	brede	40/13/8156



Toebehoren voor model 9001-EU		
Ref.	Model	CA-nummer
9001-200	borgbus	40/65/6865
9001-201	bus	40/74/1170
9001-203	bumper	40/74/1188
9001-208	sleutel	40/66/4620
FMD2-667	pin	40/11/0962



Model	Beitel insteek	Slagen/ minuut	Slaglengte	Zuiger-diameter	Gewicht kg	Lengte mm	Lucht-Aansl. NPTF	Slang mm	CA-nummer
Perslucht hakhamers									
9001-EU	JUMBO	900	229	27	11.2	572	3/8"	13	41/11/0205

Beitels voor FCH-20

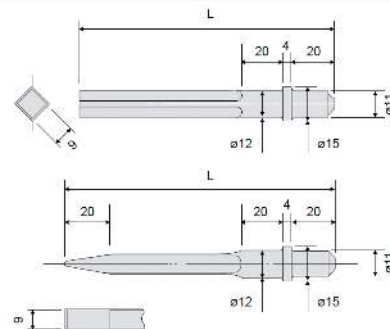

Beitel Ref.	Lengte mm	Ø Insteek mm	Ø Kraag mm	Dikte Kraag	Ø Beitel	Beitelsnede	Breedte Snede mm	CA Nr.
G-1-1	125	11	15	4	9	Blank	-	59/51/2051
G-1-2	155	11	15	4	9	Blank	-	59/51/2052
G-1-3	200	11	15	4	9	Blank	-	59/51/2053
G-2-1	130	11	15	4	9	Plat	9	59/51/6273
G-2-2	155	11	15	4	9	Plat	9	59/51/6599
G-2-3	200	11	15	4	9	Plat	9	59/51/6598
G-2-4	250	11	15	4	9	Plat	9	59/50/6600
S-1	120	11	15	4	9	Punt, Gehard	-	59/51/2055
S-3	160	11	15	4	9	Punt, Gehard	-	59/51/2056
S-2	120	11	15	4	9	Plat, Gehard	-	59/51/1826

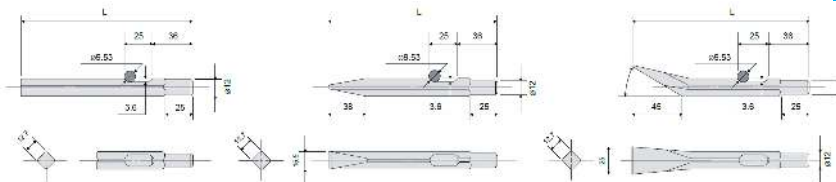

Beitels voor FCH-20F, 25 en 25B

Beitel Ref.	Lengte mm	Ø Insteek-Vierkant mm	Lengte Grendelgleuf mm	Ø Beitel	Beitelsnede	Breedte Snede mm	CA Nr.
F-1-2	155	12,7	25	12	Blank	-	59/50/6059
F-1-3	200	12,7	25	12	Blank	-	59/51/2058
F-1-4	250	12,7	25	12	Blank	-	59/51/2059
F-1-5	300	12,7	25	12	Blank	-	59/51/2060
F-2-2	155	12,7	25	12	Plat	15,5	59/50/6055
F-2-3	200	12,7	25	12	Plat	15,5	59/50/5031
F-2-4	250	12,7	25	12	Plat	15,5	59/50/5032
F-2-5	300	12,7	25	12	Plat	15,5	59/50/5034
F-3-2	155	12,7	25	12	Plat,gebogen 45°	25	59/50/6054
F-3-3	200	12,7	25	12	Plat,gebogen 45°	25	59/50/5033
F-3-4	250	12,7	25	12	Plat,gebogen 45°	25	59/50/5035
F-3-5	300	12,7	25	12	Plat,gebogen 45°	25	59/50/6334
Steenvoegbeitel 7mm dik met Widiavertanding - voor Fuji FCH-25 <i>- andere modellen Widiabeitels tevens beschikbaar -</i>					Widia tanden	35	59/38/1963

Beitels Insteek 5/8" Hex

Insteek 5/8" Zeskant (Hex) met ronding in de kraag
Geschikt voor Trelawney lange afstekers en Hakhamer Type 36

Omschrijving	Fig.N°	Lengte mm	Breedte mm	CA Nr.
Beitel 2"	1	218	50	59/27/0111
Beitel 2"SP Vonkvrij	1	218	50	59/27/0114
Beitel 4"	2	225	100	59/27/0112
Gebogen Beitel 4"	2	225	100	59/27/0131
Beitel 431-3504 - 4" met mes	2a	260	100	59/27/5152
Beitel 8"	3	260	200	59/27/0115
Vervangmes 100mm (5st.)	2	100	100	59/27/0170
Vervangmes 100mm Afgeschuind (5st.)	2	100	100	59/27/5157
Vervangmes 200mm (5st.)	3	100	200	59/27/0113
Vervangmes 200mm Afgeschuind (5st.)	3	100	200	59/27/0125
Vervangmes 300mm (4st.)	-	100	300	59/27/0130
Beitelhouder compleet voor 5/8" Hex	Bestemd voor ombouw			59/27/5020
Naaldenhouder compleet voor Afstekers	4 - Bestemd voor ombouw			59/27/5014

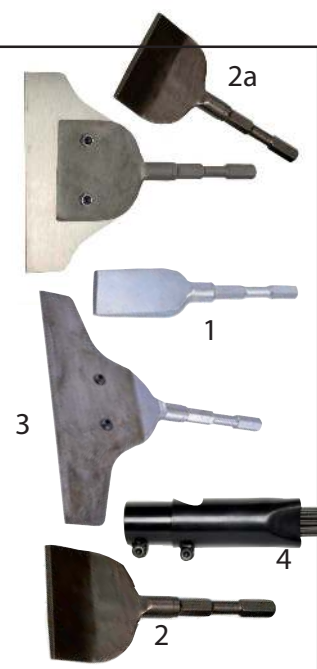

Pneumatische Heipaal

Pneumatische heipalen werden ontwikkeld voor palen met een diameter groter dan 100mm (P25) of 110mm (P50). De toestellen zijn te gebruiken voor nagenoeg alle palen in staal, hout, aluminium e.d zonder de palen te beschadigen. De bediening gebeurt door middel van een knijpventiel door één gebruiker. De heipalen kennen een uiterst lange levensduur en kenmerken zich door lage onderhoudskosten.

Model	Afmeting mm	ZuigerØ	Zuiger-slag mm	Slagen/ minuut	Gewicht (Kg)	Standaard paalgeleiding)	CA Nr.
PLC P25	290x500	92	55	2000	25	90	59/28/6680
PLC P50	280x570	50	120	1400	50	110	59/28/6685
Knijpventiel voor Heipaal	2/2 ventiel voor aansturing heipaal geleverd met 1 meter perslucht slang en klauwkoppeling						59/28/6720

Beitels Zeskant 22x82

Lengte mm	Insteek	Model	Breedte mm	CA-nummer
350	H22x82	Punt	-	59/31/0110
450	H22x82	Punt	-	59/31/0112
600	H22x82	Punt	-	59/31/0115
800	H22x82	Punt	-	59/31/0116
1000	H22x82	Punt	-	59/99/7579
1500	H22x82	Punt	-	59/31/0118
2000	H22x82	Punt	-	59/31/0419
4000	H22x82	Punt	-	59/31/0117
5000	H22x82	Punt	-	59/31/0450
6000	H22x82	Punt	-	59/31/0455
400	H22x82	Plat	23	59/31/0410
600	H22x82	Plat	23	59/31/0412
800	H22x82	Plat	23	59/31/0415
1000	H22x82	Plat	23	59/31/0416
1500	H22x82	Plat	23	59/31/0418
2000	H22x82	Plat	23	59/31/0419
2500	H22x82	Plat	23	59/99/5120
5000	H22x82	Plat	23	59/31/0460
6000	H22x82	Plat	23	59/31/0465
420	H22x82	Spade	B135xH180	41/99/0315
400	H22x82	Asfaltbeitel	B130XH400	59/31/0845



Beitels Rond R25x75

Lengte mm	Insteek	Model	Breedte mm	CA-nummer
350	R25x75	Punt	-	59/31/1910
450	R25x75	Punt	-	59/31/1915
500	R25x75	Punt	-	59/31/1919
600	R25x75	Punt	-	59/31/1917
800	R25x75	Punt	-	59/31/1921
1200	R25x75	Punt	-	59/31/1925
1800	R25x75	Punt	-	59/31/1927
2500	R25x75	Punt	-	59/31/1916
4500	R25x75	Punt	-	59/31/1922
350	R25x75	Plat	25	59/31/1918
450	R25x75	Plat	25	59/31/1920
1000	R25x75	Plat	25	59/31/1928

JUMBO Beitels voor 9001 Rivet/Breekhamer

Referentie	Lengte mm	Model	Breedte mm	CA-nummer
9001-297-9	225	Punt	-	40/13/8177
9001-297-12	305	Punt	-	40/13/8180
9001-297-18	455	Punt	-	40/13/8198
9001-276-9.1/2"	241	Plat	22	40/81/8374
9001-276-12	305	Plat	22	40/99/9800
9011-276-18	457	Plat	22	40/99/9803
9001-276-24	600	Plat	22	40/13/8179
9001-276-36	900	Plat	22	40/13/8200
9001-277-9.1/2"	241	Rivetbeitel	22	40/81/8382
9001-277-12	300	Rivetbeitel	22	40/81/8383
9001-277-18	450	Rivetbeitel	22	40/81/8384

Referentie	Lengte mm	Breedte mm	CA-nummer
Ripper - Scheider			
9001-295-9.1/2"	241	28	40/81/8390
9001-295-12	300	28	40/81/8391
Rivetuitdrijvers (RU)			
9001-278	240	Ø9.5	40/81/8416
9001-279	305	Ø13	40/81/2424
9001-282	305	Ø7/8"	40/81/8457
9001-285	240	Ø16	40/81/9801
9001-286	300	Ø16	40/81/8004
9001-281	241.3	Ø19	40/81/8440
9001-283	240	Ø25	40/81/8465

